



Modifications for the Kenwood TS-850

Picture(s) of Kenwood - TS-850

- 19-07-1998** [TS-850S observations](#) English language
- 19-07-1998** [TS-850S All band transmit](#) English language
- 19-07-1998** [TS-850S Broadcast Band Sensitivity](#) English language
- 19-07-1998** [TS-850S Additional Front Panel Functions](#) English language
- 19-07-1998** [Step by step instructions to disable the broadcast band attenuation for TS-850S](#) English language
- 19-07-1998** [TS-850? ACC-2 audio problem](#) English language
- 19-07-1998** [Adjustable moni. on CW, TS-850S](#) English language
- 19-07-1998** [TS-850 service manual, error corection](#) English language
- 19-07-1998** [TS-850S and speaker/headph](#) English language
- 19-07-1998** [TS-850 and Ten-Tec Titan 425 PA](#) English language
- 19-07-1998** [KAM-PLUS Problems!! with TS-450 & 850](#) English language
- 19-07-1998** [TS-450,TS-850 feedback,ACC-2 Conn](#) English language
- 31-03-1999** [Modification for External keying, while using the internal keyer](#) English language
- 31-03-1999** [TS-850 Separate Receive Antenna Modification](#) English language
- 31-03-1999** [TS-850 Separate RX antenna input mod](#) English language
- 31-03-1999** [The switch box](#) English language
- 31-03-1999** [Computer Interface for the TS-850, without using the IF-232 Level Converter](#) English language
- 31-03-1999** [TS-850 Power Output Control](#) English language
- 31-03-1999** [TS-850 Level Attenuator for DRU-2 playback audio](#) English language
- 22-08-1999** [TS850 + Transverter oder Preselektor](#) German language
- 22-04-2000** [TS-850S Distorted TX w/TNC connected](#) English language
- 22-04-2000** [TS-850S Low/no Receive sensitivity](#) English language

- 23-04-2000** [TS-850S No audio from VS-2](#) English language
- 23-04-2000** [TS-850S Mixer FET change](#) English language
- 23-04-2000** [TS-850S "Click noise" with NOTCH ON](#) English language
- 14-06-2001** [Full transmit for the UK version of TS-850S](#) English language
- 24-07-2001** [TS-850 2nd RX output mod](#) English language
- 26-06-2002** [A Band Decoder for the Kenwood TS-850 HF-Transceiver](#) English language
- 11-05-2003** [TS850s alc problem](#) English language
- 11-06-2003** [Noise Blanker Mod Kenwood TS-850](#) English language
- 01-11-2003** [TS-850s noise blanker mod](#) English language
- 28-11-2003** [TS-850 fan speed modification](#) English language

19-07-1998

add a comment

TS-850S observations

Observations of KC2CT

Having lived with Kenwood's TS-850S transceiver for 5 days, here are some of my observations:

- While the manual shows 35 power-on front panel adjustments, there really are 36. Function number 35 is set from the factory to the OFF state. Well, what exactly is this unknown function? Well Bunkies, this enables the transceiver to transmit on 27.500 through 28.000 mhz! Do yourself a favor, and set this option to ON for TX inhibit! DO NOT JEAPORDIZE YOUR LICENSE! Why in the world did the factory allow this??? Maybe they don't want the Chicken Banders butchering up the rigs....
- Tone control. The setup only allows Burst or Continuous modes, there is no way to turn it OFF, even though the manual indicates there is a way.
- Quick memory function. You MUST pass through either the VFO A or VFO B registers to program these.. You cannot go from standard memory to quick memory directly.
- My 850S came out of the box running low power (50 - 75w PEP), so I called the local ham radio dealer inquiring about service manual availability. Well they had them in stock, but at a price of \$50.00! Unbelievable! Kenwood wants fifty dollars for (in the continuing Kenwood tradition) a terribly organized, incomplete, and horrible reading manual!!! Well, I dug into the schematics and opened up the the radio, here's a list of items that might be of interest to some:

RF Board Controls

- VR - RX BAL
- VR - TX BIAS
- VR - TX BAL
- VR - TYP (50W output power adjust, used with S1 below)
- VR - MIN (?????) / internal antenna tuner
- VR - TUN (Tune mode power adjust)
- VR - VSF (THIS IS THE 100W POWER OUTPUT CONTROL)
- VR - SWR Protect activation

```

VR - PWM (Forward power meter calibration)
VR1 - RWM (Reflected power meter calibration)
VR1 - AL0 (ALC meter zero)
VR1 - ALM (ALC meter calibration)
VR1 - CPM (Processor meter calibration)
VR1 - ALG (ALC gain adjustment)

S - All Band Power Down Switch (Decreases power to 50 watts)

```

IF Board Controls

```

-----
VR      -
VR      -
VR      -
VR      - Beep volume
VR      - Sidetone volume
VR      - Processor adjust
VR      - ??????
VR8 & VR9 - ??????
VR1     - ??????
VR1     -
VR12 & VR13 - S Meter adjust
VR14 & VR15 - AGC adjust
VR1     - Notch filter adjust

```

- **PLEASE NOTE!**
Most of these controls are 1/8" pots, so if you intend to adjust them use a VERY SMALL non-metallic tool.
- My 850S also came out of the box with the RIT/XIT control not displaying 0.00 khz at fiducial (12 o'clock position) center. Behind the front panel in the upper right corner is the control for center adjust. It just needed a wee bit of tweaking... Along with this control on the circuit board are the master adjustments for the SSB slope tuning (High Cut and Low Cut).
- When both top and bottom covers are removed, on the left-hand side is the FM board. There are 3 (three) pots on the board. They are FM Wide (12khz) deviation, FM Narrow (6khz) deviation, and FM Mic gain.
- FM mode defaults to WIDE (12khz). This is WAY too wide for accessing any 10m repeater. Hit the 455khz filter button again for FM-N (narrow). This will set the IF to 6khz width, and you be able to work FM 10m stations. Note: The 8.83 filters are NOT selectable in FM mode.
- Memory scrolling via M CH./VFO CH. You can bypass all unused channels if you press the 1 mhz button. With the button active, only stored memory channels will be displayed as the knob is rotated.
- Tuneable memories. Out of the box, the radio is set up for non-tuneable memories. Just bring up setup function xx on the display, and set it to ON, and ALL memories can be tuned via the VFO. When use the M.CH/VFO CH. switch you will be returned to the original frequency & mode setting in the memory.
- It may or may not be obvious to some, but the radio is capable of cross-band and/or cross-mode operation. Just pump the required modes and frequencies into memory channels or VFOs, and you're off and running. Hope you have a very broadbanded antenna!
- CW message storage is lost when you power off the radio. I didn't order the DRU-2 option (yet), so I don't know whether these messages will be saved. You'd think that with everything else that is stored in RAM and backed up by battery, that Kenwood would have made provisions to keep recorded messages alive also. A modification????
- When adding additional filters, is is necessary to set the corresponding switch on. Under the hatch on top, is a 4 position dip switch. The manual shows a picture of it, but makes no mention of their settings. This switch is necessary to inform the micro-processor of the filters' absence or presence. ON is for presence, OFF is for absence. Below is the switch diagram:

```

-----
| = | <-- YK-88C-1, YK-88CN-1, YK-88SN-1
| = | <-- YK-88CN-1, YK-88CN-1, YK-88SN-1
| = | <-- No Function
| = | <-- YG-455C-1 or YG-455CN-1
-----
O   O
N   F
    F

```

- I received the DRU-2, voice recording unit this week, and installed it. Here's what I found:
- The unit comes with a lithium battery for backing up the voice messages when the rig is powered off.
- The initial state of the DRU-2 is:

Message 1 - 8 seconds
 Message 2 - 8 seconds
 Message 3 - 16 seconds

You can halve the sampling rate via front panel setup control xx. This will effectively DOUBLE the time of each message, however, the quality of voice reproduction will suffer because of the lower sampling rate.

- On playback of the messages, the microphone IS NOT disabled, so be quiet when you're transmitting stored messages.
- Use the MONI function to hear what you've recorded and/or are transmitting, and the MIC gain control to keep the ALC in range, as the DRU-2 drives the radio much harder than the microphone input.
- The high boost function and speech processor are available to the DRU-2 during transmit.
- I also got the VS-2 voice unit. The voice is the same as the older VS-1 for the TS-440, and TS-940, but the unit is in a smaller package. It will speak the frequency in either English or Japanese. There is a volume control pot on the bottom of the board which should be adjusted PRIOR to screwing down the VS-2. The output on my unit was very low, until I tweaked it up. Also there are jumpers on the board to speed up the voice playback... You'll need to consult the instruction page for the VS-1 for speeds, as there is nothing mentioned in the instructions for the VS-2.
- A note on output power of the rig. The radio uses 2SC2789's... These devices are rated as 100 watt devices Kenwood is running the finals VERY conservatively. When playing around with output, I had the rig dead-keying 175 watts, but backed it down to 100 watts, as I didn't want to blow up the rig, but I was definitely smiling as the Birds' meter swung with a 250 watt slug!
- The ROM chip on the digital board is socketed. Kenwood had problems with early 440's and 940's with poor soldered connections. While it's a nice idea to allow removal and replacement of the ROM to add features/fix bugs, this might become a problem area in the future.
- Hidden function!!! If you turn on the radio while holding down the VOICE button, EVERY button on the radio will acknowledge its function via morse code! This is a terrific feature for sightless hams! I can't understand why it is not mentioned in the owners manual or marketing literature!

This modification has been read 7038 times.

[top of page](#)
[add a comment](#)

19-07-1998

TS-850S All band transmit

[add a comment](#)

Kenwood markets this radio worldwide, and has made provisions to allow the radio to transmit between 1.625 mhz and 29.999 mhz.

I am providing this modification for INFORMATIONAL PURPOSES ONLY! DO NOT TRANSMIT OUT OF BAND, THIS WILL JEAPORDIZE YOUR LICENSE, AND HAVE THE FCC, AND/OR INTERNATIONAL AUTHORITIES KNOCKING AT YOUR DOOR!!!

The All-band transmit modification requires the removal and re- location of a diode on the the digital board which is located behind the front panel. The US version of the radio has diode D11 installed, and diode D9 removed. D11 must be removed, and installed in the D9 position. This modification IS NOT for the faint of heart, as it entails removing the front panel, and the digital board. Note that the digital board has solder holes that are through-soldered; that is, there are circuit traces on both sides of the board, so make sure that ALL solder is removed from the holes. This modification will also allow the antenna tuner to tune anywhere the receiver is tuned. This modification should ONLY be performed by those familiar with soldering and de-soldering techniques, and requires patience, and dexterity.

Thanks to [Bill KOZL](#) for this picture.

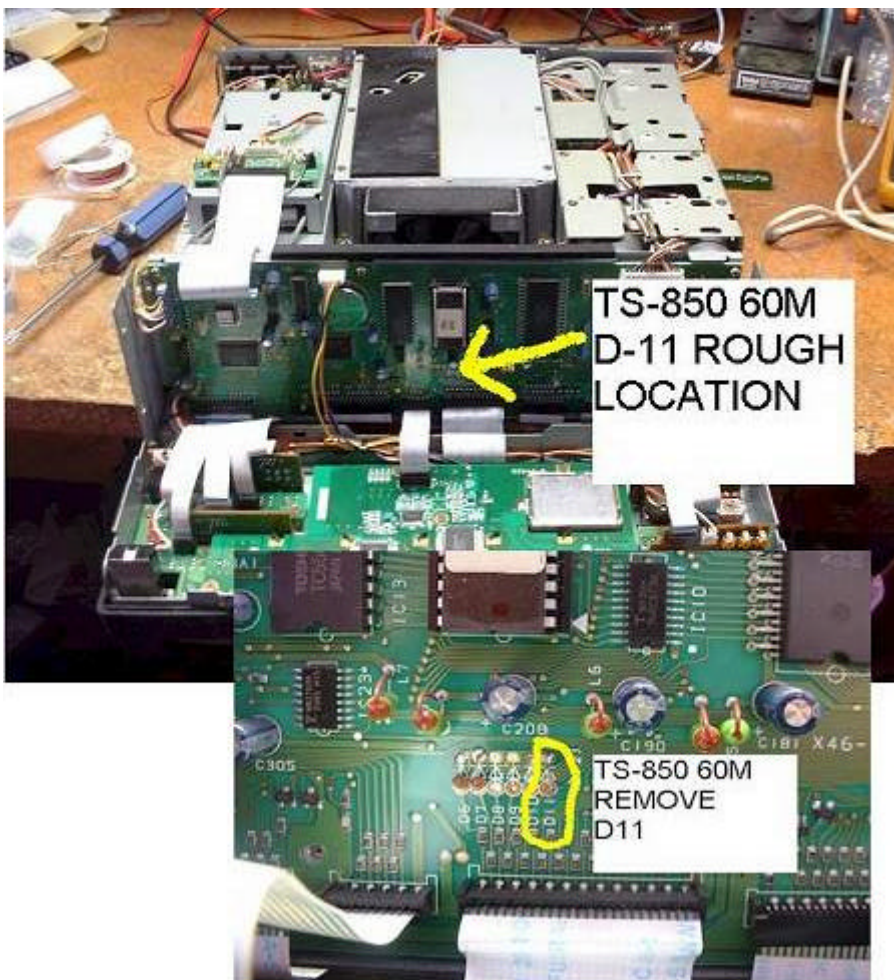

Date: 29-08-2002

User comment

From: Max VE3TMT

Subject: Diode not needed in D position

On some TS850's it is not necessary to install a diode in the D9 spot. Clip D11 (the one on the right end) and check for proper results first. On my TS850 it worked without putting a

diode in D9.

Date: 17-06-2003

User comment

From: Jaye

Subject: Full TX on the Kenwood TS-850s

I have recently preform the modifcation on the TS-850s for full TX, i have to coment that i did'nt have any dramas with this procedure,But!where it explanes to remove the diode D-11 then replace in the D-9 postion this is not nessary, just clip D-11 and you will also have remove diode D-12 that is in parallel series on the back of the digital board, this requires removing the hole digital board to gain access to Diode D-12, also will coment that the board is not easily removed, due to the funny looking screws which kenwood have placed on the board(you will need a special tool or some smart thinking) in regards to the D-9 diode??? no go on this rig! and yes it wasn't to hard! ,actually had 3 stubbies of VB (Beer) then i was back on the air, best of luck Jaye,your Mate Down Under. :-))

Date: 03-09-2003

User comment

From: Fred - G0 AOJ

Subject: TS850 TX Modification

I performed the wide TX modification some time ago, although it is a bit trickey all I did was snip one leg of D11 diode located on the digital board and it worked. Be careful not to pull any of the ribbon type cables off when tilting the front panel forward as I managed to do and I needed the hands of of 2 year old to get it back but I manged it...!!

This modification has been read 8789 times.

[top of page](#)
[add a comment](#)

19-07-1998

[add a comment](#)

TS-850S Broadcast Band Sensitivity

BCB sensitivity REALLY suffers as a 24db attenuator is inserted when band-switched. This attenuator circuit is very similiar to the TS-430/440. Possible modification?

This modification has been read 5392 times.

[top of page](#)
[add a comment](#)

19-07-1998

[add a comment](#)

TS-850S Additional Front Panel Functions

Pressing SCAN + TX-M.CH will set the radio into its extended function mode. These options can be scrolled via the M.CH/VFO CH. switch. The following are the extended functions:

- 00 - This is the ROM Cchecksum displayed as a 4-digit hexadecimal number This cannot be changed.
- 01 - Allow filter selection in transmit. Initially set OFF.
- 02 - Antenna tuner power down. Initially set to OFF.
- 03 - Antenna tuner non-stop mode. When set to on, the antenna tuner will not stop when the lowest VSWR is found. Initially set to OFF.

- 04 - Store mode, and filter settings prior to changing bands, or channels. Initially set to ON.
- 05 - Display -HELLO- on digital display, and send it in Morse code on power up. Initially set OFF.
- 06 - Turn full LCD display ON on power on. Initially set OFF.
- 07 - Turn Subtone ON or OFF. Initially set ON. Note that even when set off, the TONE indicator will be lit on the display.
- 08 - Unknown. Initially set OFF.

This modification has been read 6902 times.

[top of page](#)
[add a comment](#)

19-07-1998

[add a comment](#)

Step by step instructions to disable the broadcast band attenuation for TS-850S

This mod greatly improves the sensitivity and likewise the reception on the AM broadcast band.

No noticable unwanted side effects have occurred following this procedure.

I live within three miles of a 5,000 watt broadcast station on 1150 kc's and am able to listen to stations on either side of that station. There is some splatter but using the notch filter and the attenuation on the front of the radio takes care of that for the most part. This is *NOT* complicated and can be done in fifteen minutes. Only one caution here:

you WILL BE SOLDERING TWO POINTS ON A CIRCUIT BOARD THAT IS LOADED WITH SURFACE MOUNTED COMPONENTS!!! There is little room to work on the board, so be very careful with your iron! If you don't feel comfortable soldering, get someone else to do it as you can cause a solder bridge and ruin your radio without even trying. With that in mind, here goes:

1. remove the eleven screws that secure the bottom cover to the rig. the six ones on the sides and the five on the bottom cover itself.
2. remove the bottom cover. there are no wires attached to the cover. lift it right off. leave the top cover of the radio ON.
3. locate the RF BOARD. it's number is: X44-3120-00. this is the board where you plug the optional filters into. with the open radio in front of you, and the front of the radio facing you, the RF BOARD is the one on the left. (there are only two boards under the bottom cover)
4. locate the chrome like shield on the rear of the RF BOARD. it's made out of shiny steel. remove the four screws that hold this shield to the board.
5. remove the shield by lifting the front of it up while sliding it forwards, towards you. watch out for all the little wires and ribbon cables going to and from the RF BOARD.
6. look at the rear of the board and towards the left corner.(the radio is still facing you upside down) notice two I/C's numbered IC1 and IC2. directly behind the I/C's are a bank of adjustable coils in metal cans. there are nine of these coils in a group. directly to the left of these coils are many green and red inductors which are standing up. they look like resistors but they're really small coils.
7. these inductors are part of the bandpass filtering for each of the bands on the radio. the capacitors and resistors that complete the bandpass filtering are on the other side of the board and are of the surface mount type. you are only concerned with the bandpass filter for the .5 to 1.6 band. notice the numbers for the inductors. find L8 and L9. they are right at the edge of the board in the left rear corner you will notice that .5

Sorry, that's the best art work I can do. The purpose of the jumper is to bypass the two 150 ohm resistors that are in series after the bandpass filter. The resistors add between 20 and 25 db attenuation to the AM broadcast band. For some reason, Kenwood thinks that the receiver would become overloaded by strong nearby broadcasting stations, which would cause distortion. I simply don't find that to be the case. It's funny, Kenwood already had those two points there on the board, but without the jumper.....it seems to me that they had anticipated the need to bypass the attenuation in Europe or Asia. Thus, all export models going to the states were missing that jumper. Who knows? I can't find any other reason for the jumper points to be there.

Anyway, you'll notice an immediate increase of signal strength. You'll hear stations that you never knew were there! As I said, if you are bothered by strong stations in your area, try using the 6 and/or 12db attenuation buttons on the front of the rig.

This modification has been read 5268 times.

[top of page](#)
[add a comment](#)

19-07-1998

[add a comment](#)

TS-850? ACC-2 audio problem

Following bulletin was sent to me by Dick, KB8DB:

KENWOOD/KAM SSB AUDIO PROBLEM

The problem is that some kenwood radios are being shipped with the rear panel audio output very sensitive. We (kantronics) have had others report the same problem, and the following response was prepared by our service department: Some adjustments in the radio and in the kam may be necessary when using these connections. SOLUTION:

Decrease the gain in the kenwood radio rear panel audio input circuit (may be labeled vr18, check your radio manual).

Increase the afsk output from the kam (remove jumper k5 for maximum output).

Set the kam to transmit in rtty mode, and radio in ssb mode, adjust vr18 (or gain control in radio that controls rear panel audio input) for the radio manufacturer's recommended output when using rtty.

Now, when using the front panel microphone, low-level noise on the rear panel input will not be picked up or added to microphone audio. (unquote)

73 from Stan G4KSJ @ GB7BEN.#43.GBR.EU

This modification has been read 5144 times.

[top of page](#)
[add a comment](#)

19-07-1998

[add a comment](#)

Adjustable moni. on CW, TS-850S

Hello everybody!

If you'd like to be able to adjust the volume with your "MONI-knob" on the frontpanel of your TS-850S when monitoring your transmission on CW read this! Originally it's a fixed level

controlled by VR5 internally.

This could be usefull when switching between the loudspeaker and the headphones.

When you're monitoring your CW with headphones at a pleasent level, and then disconnect the headphones and monitoring with the loudspeaker the audio is quite low.

(IF-UNIT)

- Remove the IF-UNIT (you must solder on the rear side of the IF-UNIT). Be carefull to mark all the cables before you remove them!!!
- Remove R239 (330 kohm, close to VR5).
- Install a new resistor (330 kohm) from the output of VR5 to the junction R229, R230, R231 and C172 (rear side of the IF-UNIT, close to IC7).
- Adjust VR5 to maximum audio level.

Now you're able to adjust your audio level in the CW mode with the "MONI-knob" at the frontpanel of your transeiver.

Gif file of the circuit board [layout](#) (445 Kb) where the mod is to be done in the radio.

73 de Nate Bargmann

Packet: KA0RNY @ WFOA.#SCKS.KS.USA.NOAM

E-mail: ka0rny@midusa.net

Valley Center, Kansas USA EM17hs

Visit my Linux + Ham Radio pages homepage.netspaceonline.com/~ka0rny/

This modification has been read 4927 times.

[top of page](#)
[add a comment](#)

19-07-1998

[add a comment](#)

TS-850 service manual, error corection

Page 20:

2 Full break-in operation timing

...signal enters pin 10 of the BW-SW module from the...
should be

...signal enters pin 10 of the BK-IN module from the...

Page 21:

Resistor R3 (10 kohm) in the BK-SW schematic does not exist.
(This is corrected in the schematic that's in the user's manual)

Page 23:

Key up

In line 8 and 10 capacitor C230 is mentioned
-should be C231

This modification has been read 5470 times.

[top of page](#)
[add a comment](#)

19-07-1998

[add a comment](#)

TS-850S and speaker/headph

This is a very simple modification on the TS-850S to be able to hear the receiving station through the loudspeaker and the headphones at the same time.

On ICOM rigs it does not require any modification at all as this is a feature built-in from the factory.

On ICOM rigs if you push the connector halfway into the headphone jack you have the sound in both the loudspeaker and the headphones, then if you push the plug the whole way in, the sound is only in the headphones.

Unfortunately this is not the case on the TS-850S.

The headphone jack is a little different made on Kenwood rigs, so this modification does not allow you this "halfway" feature described above. But still you are able to have the sound coming from the loudspeaker and the headphones at the same time.

Modification.

Note!

This modification works on both mono and stereo headphones.

1. Remove all knobs at the front of the radio.
2. Remove the front.
3. Remove the very small unit (E/6 page 57) that contains the phone jack itself.
4. Install a jumper between pin no. 1 and pin no. 2 on the CN8 connector.

This modification has been read 5195 times.

[top of page](#)
[add a comment](#)

19-07-1998

[add a comment](#)

TS-850 and Ten-Tec Titan 425 PA

If you're using the Kenwood TS-850S with the Ten-Tec Titan 425 linear PA read this!

This explains how to modify the TS-850S' full QSK feature and avoiding "hot switching" the relay in the amplifier when operating full QSK.

As you probably know the correct way to prevent "hot switching" is to feed a signal to the Titan's "key-in" connector when you transmit. When the linear's vacuum-relay is settled the Titan's "key-out" connector return that information to the transceiver which then feed its output RF to the linear.

What's important here is that the transceiver DOES NOT feed any RF BEFORE the vacuum-relay in the linear is settled!

(If you do, you have the problem called "hot switching")

This is how to overcome the "hot switching" problem:

Open the TS-850 and do the following:

1. Remove the original TRX-relay (K3 at the RF unit).
2. Remove the IF unit.
3. Locate the BK-SW unit (X59-3880-00).

Cut between Q2's collector and pin 10 on the BK-SW unit.

Feed Q2's collector to the "key-in" on the Titan linear.

Feed pin 10 (where you cut) on the BK-SW unit to the "key-out" on the Titan linear.

4. Reinstall the IF-unit.

That's all!

I connected the collector of Q2 to pin #4 on the REMOTE connector and pin #10 on the BK-SW unit to pin #2 on the REMOTE connector at the rear of the transceiver where you originally connect the keying of an amplifier.

That's why you should remove the TRX-relay (K3) as described in point no. 1.

Pin 4 on the remote connector should now be connected to the "key-in" on the Titan amplifier

Pin 2 on the remote connector should now be connected to the "key-out" on the Titan linear.

ONLY use shielded cables!!!

This modification works fine on my TS-850. I am able to operate full QSK at the maximum speed on the built-in keyer unit without risking any damage to the vacuum-relay in the Titan at full output power (1600W).

This modification has been read 4797 times.

[top of page](#)
[add a comment](#)

19-07-1998

[add a comment](#)

KAM-PLUS Problems!! with TS-450 & 850

Hello All,,

A common problem when using a KAM-Plus multimode with the Kenwood TS-850 or TS-450 occurs when the KAM-Plus is coupled to the Accessory-2 socket on the back of the transceiver, producing noticeable distortion of the transmitted audio when using the microphone in SSB mode..

The problem is easy to cure by disconnecting the Accessory-2 plug from the back of the transceiver, but this meant moving the transceiver around every time one wished to operate on SSB..

The problem is caused by the input sensitivity of the rear Accessory-2 socket being set to high, so that it picks up very low level noise from the KAM-Plus and associated computer wiring, this mixes with the microphone signal, to produce the distortion.

The cure is to reduce the input sensitivity of the radio, thus reducing the chance of distortion, also it goes without saying that the output from the KAM-Plus must be increased to compensate for this.

With both the TS-450 and TS-850, adjusting the input sensitivity is straight forward and the transceiver manuals show you the appropriate control and its location.. This is in both cases

VR18 to be found on the main board of the radio,(refer to manual) in practice I found that it was best to adjust this control fully counterclockwise..

Then we need to adjust the output from the KAM-Plus by varying potentiometer R28 and setting removable link (K9), this link is factory set on one post only, (in the open position)!! this should be connected shorting the two posts, thus putting the KAM-Plus into the high output position, and then potentiometer R-28 is adjusted to give full power out from your HF radio with very little ALC deflection, when the MIC gain is in the normal operating position..

Then I am sure you will find that your problem is over, you can now simply change from digital modes to SSB.. Remember if you have your Beacon activated to turn it OFF or it could cause a few comments when operating SSB..

This modification has been read 4697 times.

[top of page](#)
[add a comment](#)

19-07-1998

[add a comment](#)

TS-450,TS-850 feedback,ACC-2 Conn

Hi if you are using the ACC-2 connector to interface with your multi-mode controller, you may have had a problem with your transmitted audio signal being distorted, to eliminate this see bellow.

1. Set your meter on the radio to read ALC
2. PK232 OWNERS: if also using a VHF transceiver, adjust the AFSK level for proper VHF operation as explained in chapter 3 of the operating manual.If not adjust for proper SSB operation.

DSP - 1232 / DSP - 2232 Owners: Adjust the appropriate AFSK level control for proper SSB operation as explained in chapter 3 of the operating manual.

3. Place the TNC in calibrate mode and press K to key the radio.
4. Adjust VR-13 on the TS-450 or VR-18 on the TS-850 so that the meter "Just comes off the peg" as described in the section titled "SSB Tranciever Final Adjustments" (in the TNC operating manual).
5. Press Q to quit the CALIBRATE mode

This modification should not affect any of the other normal operations of the radio..
Copy of service bulletin from AEA

This modification has been read 4824 times.

[top of page](#)
[add a comment](#)

31-03-1999

[add a comment](#)

Modification for External keying, while using the internal keyer

Author: N7EX (ex-N0DH), Dave Henderson

One of the minor draw backs to the TS-850 as a CW contest machine is the inability to use the internal keyer in conjunction with an external keying circuit such as a personal computer or auxiliary memory keyer. As designed you must manually throw a switch from internal to

external keying to switch between one or the other. To make matters even more inconvenient this switch is on the back of the unit and is not readily accessible during normal operation.

Simply said this modification involves running a new keying line from the junction of S1 and D51 on the IF Board. For convenience this additional keying line can be wired to the DSP1 and/or DSP2 RCA phono jacks if you do not use the external DSP unit.

The modification to the unit to resolve this problem takes less than 30 minutes to accomplish and can be done without "permanently" modifying the unit which would detract from its future resale value. If you don't use the external DSP unit then the two RCA phono jacks marked DSP1 and DSP2 can be used as additional keying input jacks as will be outlined below. If you use the external DSP unit then the modification can still be accomplished by running the external keying line out on a "pigtail." I highly recommend the purchase of a service manual which will greatly improve your ability to indentify the circuit points involved in the modification.

Considering that the radio costs \$1500 what's another \$30 to keep from messing it up! By the way compared to the two TS-930's that I nursed through the 80's, this radio is a breeze to trouble shoot and repair which I have had to do twice through no fault of Kenwood (long stupid story ~8>).

From here you proceed at your own risk, if you fry the radio DON'T CALL ME. A precision low wattage solder pencil for doing surface mount soldering is recommended, If all you have is a 150 watt Weller solder gun then read no farther your better off taking the unit to an expert rather than "melt" the circuit traces.

I assume no risk for the accuracy or completeness of the enclosed information. All yee who enter here embrace all hope for you may likely have a better contest radio when you are done.

1. Turn the unit upside down with the back of the TS-850 toward you.
2. Remove the bottom cover.
3. In this position the IF board is on your left.
4. Remove all the screws holding the IF board to the chassis.
(put them in a jar or something for safe keeping).
5. Unplug enough of the cabling to allow you to tilt the board up so that you can access the bottom side of the board underneath S1 the "External/Internal" keying switch.
6. On the bottom side of the board directly underneath S1 you will see 6 solder pads arranged in two rows of three pads each.
7. The middle pad on S1 nearest the back of the radio should be GROUND, solder the braid of an approximately 9 inch piece of small audio style shielded cable to this point, being careful to dress the coax so as not to short to other circuitry.
8. The middle pad on S1 in the next row up of three pads is the keying line. Solder the center of the shielded cable to this point.
9. Route the other end of the shielded audio cable through the chassis in the vicinity of the DSP jacks above.
10. Carefully inspect all solder joints for shorts, etc. Replug the wire harnesses unplugged in step 5 above and reassemble the board to housing. Reassemble the bottom cover.

11. Turn the unit over and remove the top cover.
12. Find the DSP input board with the three RCA phono jacks on it at the rear of the unit. The two DSP jacks are on the right when facing the rear of the unit. There are two connectors on this board (a 2pin and a 4pin). Unplug the 4 pin connector. Obtain another 4 pin connector and connect as follows (or directly solder to the underside of the board as follows) If you only need one additional CW jack then ground is pin 2 (closer to center of the radio) connect the braid of your new key line to this pin. The input from the middle RCA phono plug is pin 1 connect the center conductor to this pin. Like wise if you want two additional CW jacks then do as above plus add a short between pins 1 and 3. If you want a small RF choke or some ferrite beads on the center conductor of the audio cable may prevent keying problems in high RF field environments...
13. Close the unit up and switch S1 to INTERNAL keying. You should now be able to key the unit via the internal keyer (Via the standard key input jack) or with an external keyer or computer via the old DSP jacks, without having to switch S1.

This modification has been read 4676 times.

[top of page](#)
[add a comment](#)

31-03-1999

[add a comment](#)

TS-850 Separate Receive Antenna Modification

Author: Brian, WA3WJD

Make a short loop of white telfon cable with a male and female BNC connector.

Loop it out of the back of the rig so just enough of the coax sticks out so the BNCs can be joined with a barrel connector.

Locate the little header connector on the filter board in the TS-850 that is on the receiver side of the TS850 antenna relay. Pull that connector loose.

Spend a little time tracking down male and female header connectors that match what Kenwood uses. Install those on the ends of the white teflon coaxes sticking in the back of the radio.

For normal use, just connect the BNCs with a barrel connector and the rig is normal. For Beverage use, connect an extra antenna switch common and ant #1 to the BNC connectors, and put ur Beverages on the other positions.

This modification has been read 5169 times.

[top of page](#)
[add a comment](#)

31-03-1999

[add a comment](#)

TS-850 Separate RX antenna input mod

Author: N6TR - n6tr@teleport.com.MODIFICATION.NET

This is near the top of everyone's list when they are asked "What things bug you about the TS-850S." I initially overcame this deficiency by modifying my amplifier so I could connect a

different receive antenna to the TR relay. However, I wanted to change things so there wasn't as much RF getting into the RX antenna due to close proximity to the amplifier's output. This became a problem when using the same receive antenna on a second radio (you knew two radio contest operating was going to work its way in here somehow).

Ville, OH2MM had provided me with instruction on how he modified his TS-850S to have a separate RX input and this inspired me to try it.

Here are some simple steps to hopefully inspire others:

It took me an unrushed two hours to do all this.

1. Remove the top panel (you don't need to take off the bottom one).
2. Remove the plate which sits between the fan and the back of the radio. This covers the output filter PC board.
3. Unsolder the connections to the SO-239 output connector.
4. Remove the three cables from the PC board next to the SO-239. This includes two coax and one 3 conductor harness.
5. Remove the two screws holding in the PC board and remove it.
6. Locate the trace that goes from the relay's normally closed contact. You can use an ohm-meter to find it - probe from the wire that went to the SO-239. You will find a short trace on the back of the board which runs to a chip capacitor. Cut this trace and solder some very small coax to each side of the cut - connect ground to the nearby ground trace.
Make the cables about 4 inches long.
7. Remove the antenna tuner. There are 2 screws in the back and front (you will need a magnetic screw-driver) and one on the side. You will need to carefully unplug two wire harnesses and one coax connector.
8. Drill two holes for phono jacks on the back of the radio. Be careful not to obstruct the screw hole for one of the screws in the back of the antenna tuner. The best place is between the RF output connector and the groundpost. Put them on top of each other and as close to the bump on the back panel as possible. I used a vacuum cleaner while drilling to make sure no metal chips went anywhere.
9. You will find a small hole under the SO-239 where you can feed the two coaxes through. Solder them to the phono jacks and reassemble everything. I put back to back diodes on the RX antennas input, but you may not want to do this. A better thing would be to add a relay to disconnect the RX antenna input when transmitting. I took care of that in project #2.
10. Obviously, you will need a jumper cable to make your receiver work again.

This modification has been read 4923 times.

[top of page](#)
[add a comment](#)

31-03-1999 **The switch box**

[add a comment](#) 

Parts list:

- 4 position rotary switch
- DPDT 12 VDC relay
- 1 K Ohm pot (optional)
- 12 phono jacks (or you can get by with 9)
- mini box for above and knobs.
- Clamp diode for relay coil if not included in relay

This box does two things: disconnects the receive antenna input when transmitting and allows selection of the transmitting antenna or one of three RX antennas when receiving. The pot can be used for RF attenuation if your rig doesn't have one.

The relay gets controlled by the PTT output from your rig that normally would go to your amplifier. Then one set of the contacts is used to key your amplifier. Don't forget to put a diode across the coil of your relay if there isn't one internally. Otherwise, you will have undesired arcing across the contacts of the relay in your radio.

The other set of contacts disconnect the output of the rotary switch when transmitting. The rotary switch selects either the signal coming from the transmitting antenna (from the TR relay in your rig) or one of three receiving antennas. I use two phono jacks per RX antenna so I can feed them to other boxes for other radios. I also use two jacks for +12 volts so I can jumper power to another box.

You can build up one of these boxes in an hour or two. You can epoxy the relay to the mini box.

If you want the pot there to act as an attenuator, I just hook it up like you would a volume control: one end is ground, the other end goes to the output of the rotary switch and the wiper goes to the output. Use shielded cable as much as possible to avoid stray pickup.

[top of page](#)
[add a comment](#)

This modification has been read 5121 times.

31-03-1999

[add a comment](#)

Computer Interface for the TS-850, without using the IF-232 Level Converter

By N6TR and possibly others, with zener idea added by K6LL.

Note: This interface will work with "TR," contest logging software by N6TR. Click here for links to TR and other contest logging software packages, including shareware.

Computer Interface:

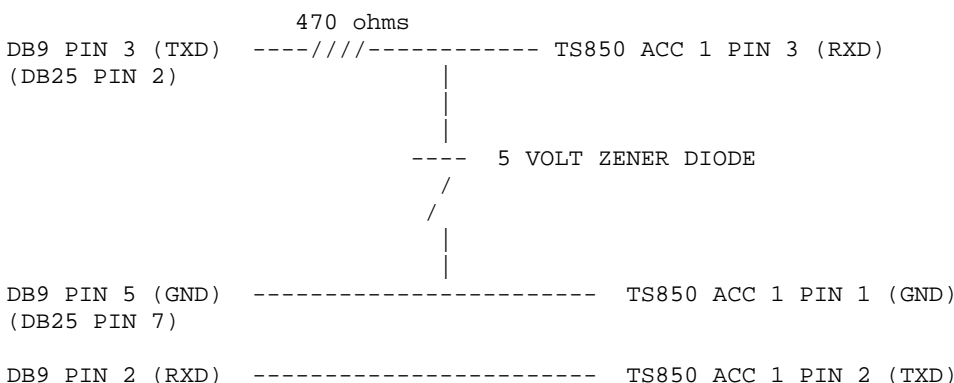

(DB25 PIN 3)

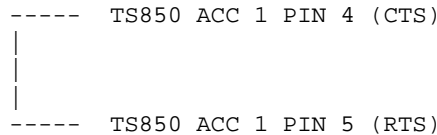

This modification has been read 5734 times.

[top of page](#)
[add a comment](#)
31-03-1999

add a comment

TS-850 Power Output Control

VR7 on the RF Board (bottom side of radio). 125 watts or so on cw is safe. Do not exceed 100 watts on SSB, since distortion will broaden the transmitted signal.

This modification has been read 6709 times.

[top of page](#)
[add a comment](#)
31-03-1999

add a comment

TS-850 Level Attenuator for DRU-2 playback audio

Author: K6LL - k6ll@juno.com.[MODIFICATION.NET](http://www.MODIFICATION.NET)

1. Remove the little hatch on the top of the radio.
2. With the front of the radio facing you, find connector CN505. It is a five pin connector near the filter DIP switches. The white wire on the leftmost terminal carries the DRU audio output.
3. Cut the white wire and insert a 100K ohm micromini pot, shunted with a 220 pf capacitor. Adjust the pot until DRU playback level matches live microphone level.

Dave Hachadorian, [K6LL](http://www.K6LL)

This modification has been read 4574 times.

[top of page](#)
[add a comment](#)
22-08-1999

add a comment

TS850 + Transverter oder Preselektor

Author: Werner Maier, DL4NER - dl4ner@qsl.net.[MODIFICATION.NET](http://www.MODIFICATION.NET)

Wenn man von hinten auf den TS850 schaut, ist rechts eine komplette Leiste mit Steckern (ACC, diverse Cinch (ALC etc..)) usw. Oben sind zwei Reihen und unten ist noch eine dritte Reihe. (da ist auch die Cinch IF-Out dabei, die original (lt. Manual) benutzt



werden sollte. Mir persönlich hat das mit den 12 Volt nicht gefallen; das Risiko für Transverter und Nachsetzer bei Ausfall der 12 Volt war mir zu groß!

Genau dazwischen (oben 2 Reihen, unten 1 Reihe) ist rechts ein Platz von ca. 2cm hoch, 8cm Breit und 3 cm tief. da passen die benötigten 4 Cinchbuchsen (drvout, drv in, ant out, ant in) problemlos hin.



Diese muß man für den normalen KW-Betrieb nur außen mit Cinch-Cinch-Koaxkabeln brücken. Da es sich um Kurzwellen (d.h. $f < 30\text{MHz}$) handelt, dürfte die auftretende Dämpfung vernachlässigbar sein.

Zudem gibt es dort in den Gehäuseverstreibungen IDEAL Platz zum Kabeldurchführen, als ob es von Kenwood dafür vorgesehen wäre und aus Marketinggründen zugunsten des TS950 gestorben wäre. So schauts jedenfalls für

den Bastler aus. Oder der Platz wurde einfach präventiv für Stecker freigehalten... wer weiß...?

Vorgehensweise:

1. !!!!! OHNE GEWÄHR !!!!!
2. Boden und Deckel abnehmen.
3. von oben: Filterplatine (mitte) wegnehmen.
4. Gehäuserückseite abschrauben, PL-Buchse ablöten (evtl. sind hier mehr als zwei Hände hilfreich!)
5. Anzeichnen, bohren, auf genügend Abstand zwischen den Cinch-Buchsen und Gehäuseverstreibungen achten. (ca. 16 mm Lochabstand reicht, damit man sich die Finger nicht klemmt, beim Betrieb hinterher wie z.B. Stecker ziehen...) Beschriften mit z.B. ANT out, IF in, DRV out, FINAL in (oder wie's beliebt).
6. Kabel auftrennen: von der IF-Platine (wenn das Gerät umgedreht wurde, vorne links) gehen ziemlich hinten an den Steckverbindungen nach hinten mitte unten zwei Kabel weg, CN1 und CN2 (weiss und Rot/Orange/Rostbraun). Die beiden Kabel sind im Bild zusätzlich mit einem gelben beschrifteten Klebeband gekennzeichnet.
7. Das eine führt direkt zur Antennenumschaltplatine, wo auch die PL- Buchse angelötet ist. Auftrennen, Verlängern und auf 2 der Cinchs legen. Das zweite führt direkt zur Final-Unit (unter der Filterplatine). Auftrennen und auf die Cinchs führen.
8. sind die Buchsen hinten RICHTIG beschriftet? und RICHTIG verbunden? Besser mehrfach prüfen, das Teil ist teuer! Ist die Beschriftung eindeutig?

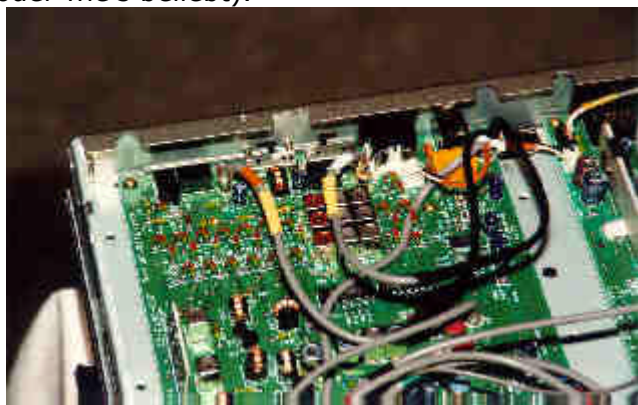

- 9. Zusammenbauen. Dabei ALLE Steckverbinder wieder stecken. Mögliche Fallstricke sind vielleicht:
 - o **Verbindung Final-Unit-out -> Filter-Unit-in ?** (muss gelöst werden, um die Filterunit auszubauen).
 - o **PL-Buchse wieder angelötet ?**
 - o Lautsprecher wieder angesteckt ?
- 10. Hinten brücken und als KW-TRX testen. Preselektor anstöpseln, testen. Transverter anstöpseln, testen.
- 11. **!!!! OHNE GEWAHR !!!!**

Das Schöne ist nun, daß man problemlos einen Preselektor dazwischenschalten kann. Ebeneso problemlos geht das mit Transverter- Betrieb, ohne Angst um Transverter und TRX haben zu müssen, falls mal die 12V Steuerspannung vom Transverter ausfällt. (Lt. Aussagen eines Fachhändlers nimmt dabei nicht nur der Transverter sonder auch der TS-850 gewaltig Schaden.).

Und: Die Signale nach Außen unterscheiden sich von der Original-Kenwood- Schaltung (->Transverterbetrieb) nur dadurch, dass jeweils ein Relais weniger in der Kette liegt.

Signal	original	modifiziert	Vorteil	Nachteil
10m-RX	direkt zur Antennenbuchse	wird nach Antennenbuchse und RX/TX- Relais zugeführt.	Preselektor-Betrieb möglich.	Ueberspannungsdioden werden umgangen. (Gewitter im Transverter? Dann ist eh' alles zu spät!)
10m-DRV	wird vor CN1 mittels Relais auf CN25 geschaltet und von dort mittels im Gerät umzusteckender Brücke auf die IF-Out-Buchse gelegt, die dann nicht mehr für ZF-Oszi geeignet ist.	wird ohne Relais nach CN1 direkt aufgetrennt.	1. Man muss nicht mehr mit 12 V schalten. 2. Wenn die DRV-Leitung aufgetrennt ist, sendet die Endstufe auch nicht.	Löcher in der hinteren Abdeckung und ein "verbasteltes" Gerät.

Rückbau: (für Verkauf, falls gewünscht):

Löcher: Kenwood-Aufkleber.

Durchtrennte

Leitungen: Ersetzen durch originale Leitungen (gibts bestimmt für Geld bei Kenwood).

73 de Werner Maier, DL4NER email: werner@mayn.de. [MODIFICATION.NET](http://www.MODIFICATION.NET) Viel Spaß mit Preselektor oder Transverter.
Zugriffe Seit 9/97:

Date: 09-05-2002

User comment

From: Stefan DL6NCY

Subject: Cinch vs BNC

Ich habe die Cinch-Buchsen aus stabilitätsgründen gegen BNC-Buchsen ausgetauscht. Nach einiger Zeit, und auch öfteren umstecken, schob sich der Innenleiter der Cinch-Buchse nach hinten, so daß der Stecker keinen Kontakt mehr hatte. Auch werden die Brücken nicht mehr so leicht verloren....

Ansonsten funktioniert alles UFB wie oben beschrieben.

vy 73/55 Stefan DL6NCY

This modification has been read 4925 times.

[top of page](#)
[add a comment](#)

22-04-2000

[add a comment](#)

TS-850S Distorted TX w/TNC connected

Author: Kenwood Communication, inc.

Service Bulletin no. 1000 (10 October 1992)

We have received several reports of distorted transmitter audio when using a TNC controller such as the AEA PK-232 or Kantronic KAM, etc. The symptom will generally disappear if the transceiver and TNC units are powered from different sources.

Cause:

The audio output level from the TNC is generally too high and causes overload of the microphone amplifier circuit. In previous models such as the TS-440S the incoming TNC audio was inserted after the microphone amplifier. With the TS-850S it is inserted before the microphone amplifier. Just moving the insertion point to the output of the circuit is satisfactory since the drive level for FM packet is higher than that required for SSB.

Procedure:

1. Add a 10 dB attenuator to the PKD line on the IF unit (X48-3080-XX). This will prevent overmodulation of the microphone input circuit.
 - a. Change chip resistor R258 from 2.2 Kohm to 1 Kohm (RK73FB2A102J)
 - b. Change chip resistor R260 from 220 to 330 ohms (RK73FB2A331J).
2. Add the following note to page 29 of the Instruction manual.
3. When adjusting for proper ALC levels with an AFSK RTTY terminal or Packet TNC terminal you should adjust VR-18 on the IF Unit for a reading similar to the one shown in the accompanying diagram.

Note: The transceiver and RTTY or TNC terminal should use separate power supplies, in order to prevent RFI (Radio Frequency Interference).

Caution: This modification requires soldering equipment rated for CMOS type circuits. It also requires familiarity with surface mount soldering techniques. If you do not have the proper equipment or knowledge do not attempt this modification yourself. Seek qualified assistance.

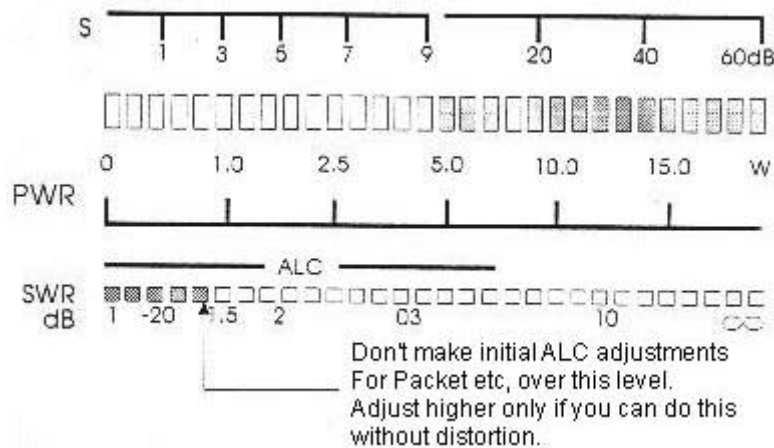

Time required for this modification is ½ hour or less.

This modification has been read 4651 times.

[top of page](#)
[add a comment](#)

22-04-2000

TS-850S Low/no Receive sensitivity

[add a comment](#)

Author: Kenwood Communication, inc.

Service Bulletin no. 1006 (22 January 1993)

Symptom:

Reports of low or no receive sensitivity accompanied by a lack of audio from the speaker during CW or SSB modes might be caused by improper RXB voltage levels. Normal RXB voltage is +8 Vdc during receive and 0 Vdc during transmit. If you find approximately + 2 Vdc during receive you might suspect a problem with a leaking diode, D31 on the RF unit (X44-3120-00).

Cause:

D31 is used as the transmit switching diode. Leakage of this diode is most probably caused by electrostatic surge or discharges from the antenna.

Parts required:

D31, MI204

Procedure: A temporary cure for units that have already been manufactured is to replace D31 with an MI204 diode. Future production radios will change D31 to an LFB01 diode and incorporate a change in the printed circuit foil pattern to allow addition of a series diode. D103 (LFB01).

Caution: This modification requires soldering equipment rated for CMOS type circuits. It also requires familiarity with surface mount soldering techniques. If you do not have the proper equipment or knowledge do not attempt this modification yourself. Seek qualified assistance.

RF Unit (X44-3120-00)

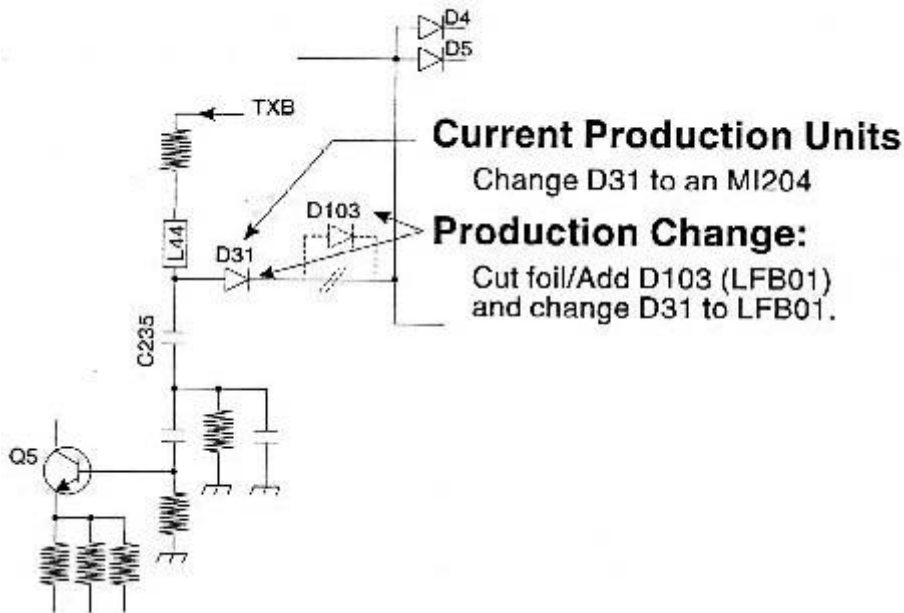

Time required for this modification is 15 minutes or less.

This modification has been read 5122 times.

[top of page](#)
[add a comment](#)

23-04-2000

TS-850S No audio from VS-2

Author: Kenwood Communication, inc.

[add a comment](#)

Service Bulletin no. 1034 (6 December 1993)

Symptom:

Several have reported a problem with the Voice Synthesizer Unit VS-2 not voicing the frequency reliably when the Voice button is depressed. This symptom is caused by a drop in the 5C voltage from 5 Vdc to approximately 4.5 Vdc when the VS-2 is connected. The following change will correct this symptom.

Parts required:

Qty	Description	Old part No.	New Part No	Circuit desc.
1	47 μ H Chip coil	L40-221-48	L40-4701-48	L501

Procedure:

Change L501 from 220 μ H to 47 μ H on the RF unit (X44-3120-00 C/4).

Caution: This modification requires soldering equipment rated for CMOS type circuits. It also requires familiarity with surface mount soldering techniques. If you do not have the proper equipment or knowledge do not attempt this modification yourself. Seek qualified assistance from your closest Kenwood Service Center (Long Beach, CA, or Virginia Beach, VA).

Time required for this modification is 30 minutes or less.

This modification has been read 4547 times.

[top of page](#)
[add a comment](#)

23-04-2000

[add a comment](#)

TS-850S Mixer FET change

Author: Kenwood Communication, inc.

Service Bulletin no. 1046 (28 March 1994)

Symptom:

Several units were discovered during production by our QC department that experienced difficult when the transceiver was being adjusted for an S-1 reading on the S-meter.

Countermeasure:

Variations in the gain of the devices used for Q16 and Q17, the second mixers, on the RF unit (X44-3120-00) appear to cause of this symptom. We, therefore, recommend replacing these two transistors with 2SK520(K43) devices. These devices have lower IDSS (Drain breakdown current), and therefore provide a greater conversion gain. As a result the total gain of the circuit is increased.

Parts required:

Qty	Description	Old part No.	New Part No	Circuit Description
2	Second Mixer FET	2SK520(K44)	2SK529(K43)	Q16, Q17

Time required for this modification is 60 minutes or less.

This modification has been read 5212 times.

[top of page](#)
[add a comment](#)

23-04-2000

[add a comment](#)

TS-850S "Click noise" with NOTCH ON

Author: Kenwood Communication, inc.

Service Bulletin no. 1049 (28 March 1994)

Symptom:

When a strong signal of S-9 or greater is received at the antenna terminal with the NOTCH circuit ON a "clicking" noise might be noticed. This is caused by excessive response in the AGC loop circuit.

Countermeasure:

The changes detailed below will add additional delay to the AGC circuit and reduce or eliminate this tendency.

Parts required:

Qty	Description	Old part No.	New Part No.	Circuit Description
1	22 Kohm chip resistor	RK73FB2A103J	RK73FB2A223J	R289
1	0.47 µF capacitor	NA	CQ92M1H474K	NA

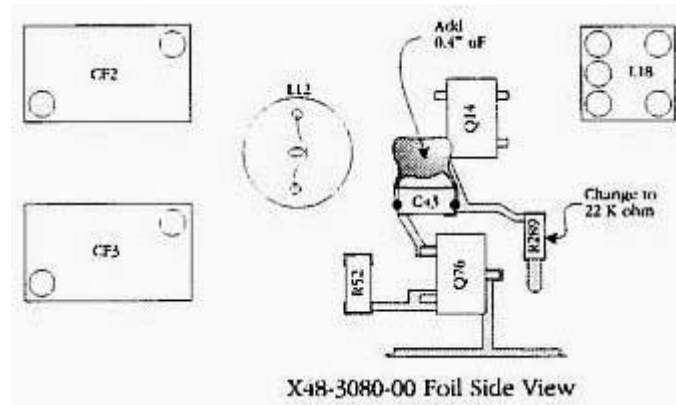

Caution: This modification requires soldering equipment rated for CMOS type circuits. It also requires familiarity with surface mount soldering techniques. If you do not have the proper equipment or knowledge do not attempt this modification yourself. Seek qualified assistance from your closest Kenwood Service Center (Long Beach, CA, or Virginia Beach, VA).

Time required for this modification is 60 minutes or less.

This modification has been read 4843 times.

[top of page](#)
[add a comment](#)

14-06-2001

Full transmit for the UK version of TS-850S

[add a comment](#)

Author: Pred - Q2_Kinani@btinternet.com. MODIFICATION.NET

This mod concerns only the UK kenwood TS-850S.

On the circuit board behind the front panel lies a bank of diodes numbered D1-D11 all diodes are there except for diode D10 to unlock the uk TS-850s to full transmit.

Just cut or remove diode D11.

Perform full cpu reset, when powering unit after modification for full reset press and hold A=B while turning on unit

Pred

Thanks to [Bill KOZL](#) for this picture.

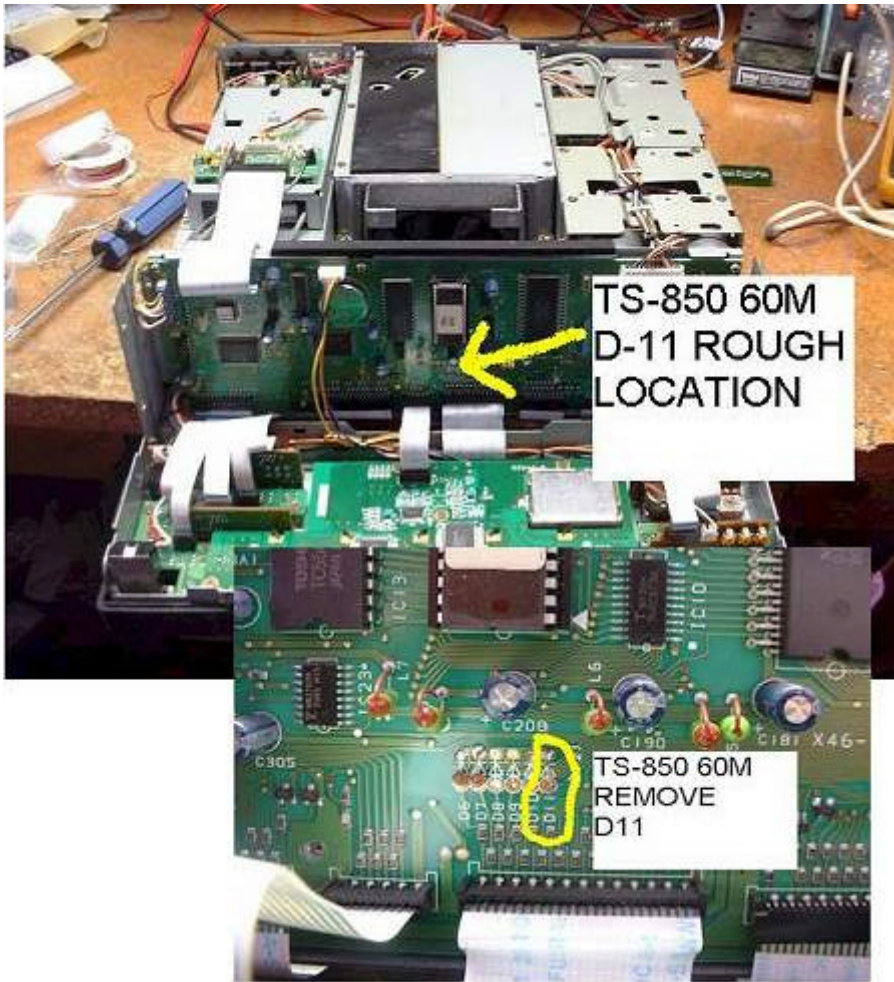

Date: 05-07-2003

User comment

From: Alan J. Masson,
K6PSP

Subject: Modifying the US version of the TS-850SAT.

In my US version of the TS-850SAT there is a group of diode positions for D6-D11 on the digital board, with only D6, D7 and D11 fitted. I cut one end of D11, reset the microprocessor, and it worked FB.

Date: 05-09-2003

User comment

From: Adrian

Subject: 136 khz access?

Is there a diode mod that allows LF transmit in the new 136khz band?

This modification has been read 5527 times.

[top of page](#)
[add a comment](#)

24-07-2001

TS-850 2nd RX output mod

[add a comment](#)

Author: Gary G4iFB - G4iFB@Amsat.org.MODIFICATION.NET

The rules for RSGB National Field Day allowed the use of a second receiver but (at least in

Restricted Section) just one antenna. The second receiver could be used as a "spotter", for example to keep an ear on 28 MHz for sporadic openings, or to check whether there is sufficient activity on another band to justify a band-change.

In the absence of a top-of-the-range transceiver with a second receiver built-in, I was prompted to make following modification to my TS850 such that an external receiver could be connected to the single antenna, yet be disconnected automatically when the TS850 transmits.

The modification is described in detail step-by-step below, but first you will need the following items:

- a small length (about 20cm) of miniature coaxial cable, for example Maplin part number XR88V (note - the characteristic impedance of miniature coax is typically 75 ohm giving a mis-match to the 50 ohm impedance of the rig and antenna system, but such a small length of cable is required that there is no noticeable effect in practice)
- a coaxial "line" socket e.g. SO239, BNC or Belling-Lee (again, the impedance mismatch caused by using 75 ohm connectors has a negligible effect in practice);
- a fine-tipped soldering iron and multicore electrical solder;
- a medium (e.g. "number 2") cross-head (Phillips) screwdriver.

NOTE: a modification such as this is liable to void the manufacturer's warranty - proceed at your own risk. It also involves a fairly delicate soldering operation so DO NOT ATTEMPT THIS unless you are competent and confident at soldering.

1. Switch off the power and disconnect all external leads to the rig. Clear a space on the table in which to work.
2. Remove the rig's top cover:
 - a. Remove 11 cross-head screws (3 on each side, 2 front and rear on the top, and the last one centrally on the top panel - don't remove the 4 screws holding the loudspeaker to the top panel!). Keep the screws safely in a container to one side.
 - b. Carefully lift the top cover until you can reach the loudspeaker cable - remove this by pulling off the small white plastic plug from the socket mounted on the printed circuit board under the loudspeaker.
3. It is probably easiest to turn the radio so the rear panel is towards you. Remove the metal lid from the TX output bandpass filter unit in the middle at the rear of the TS850, with a black rubber section attached (which normally insulates it mechanically from the top panel). There are 7 cross-head screws to remove.
4. Find the small printed circuit board immediately behind the rig's SO239 antenna connector. The black rectangular relay on this board is the main TX/RX changeover relay. Remove this board from the radio:
 - a. Carefully disconnect the two coaxial cables by pulling out the miniature pushfit plugs from the board-mounted sockets, and pull out the white plastic plug connecting the control wires to the board.
 - b. Remove both mounting screws.

- c. Unsolder the SO239 socket from the board - both inner and outer connectors need to be unsoldered - and lift out the board.
5. This is the fiddliest part of the job - get help now if you are not confident at soldering. Solder your short piece of miniature coax to the underside of the TX/RX relay board, in parallel with the TS850 receiver output connector labelled "RAT CN6". The coax should preferably exit to the rear of the board so that it will pass directly through the TS850 rear panel when reassembled. The coax centre conductor should be soldered to the "RAT CN6" pin nearest to the small coil labelled "L13", and the braid to the adjacent (centre) "RAT CN6" pin which is earthed. Check carefully that the joints are good (shiny and clean), and that no solder blobs or flakes remain on the board.
6. Pass the free end of the new piece of miniature coax out through the gauze on the rear panel of the TS850 - you may need to enlarge a hole in the gauze slightly, but the coax should be a fairly tight fit.
7. Replace the TX/RX relay board in the radio, pulling the miniature coax through the rear panel as you do so. Reconnect the board by reversing the instructions given in section 4 above - connect all three leads (two coax leads, one 3-wire lead - the plug is polarised such that it is only possible to connect it one way, namely with the red lead towards the 1k ohm vertical resistor) and don't forget to solder the SO239 back on to the board. Once again check that your solder joints are good and no wayward blobs of solder remain.
8. Replace the TX output bandpass filter unit cover and its 7 screws.
9. Replace the rig's top cover, not forgetting to reconnect the loudspeaker lead to connector "CN507" on the small circuit board connected to the front panel by a white ribbon cable as you do so. Take care not to scratch the paint when replacing all 11 screws.
10. Fit the coaxial socket to the free end of the miniature coax.
11. Check the results. Reconnect the rig and turn it on. Confirm that it receives properly. Try transmitting briefly to check that the RF output level is normal.
12. Connect an external receiver using a coax patch lead between the new socket and the antenna socket on the receiver - NOTE: be especially careful if using a transceiver as the external receiver that the second rig cannot transmit. Preferably, disable the transmitter completely. RF POWER ABOVE A FEW MILLIWATTS ACCIDENTALLY APPLIED TO THE EXTERNAL RECEIVER CONNECTOR WILL INSTANTLY BLOW THE TS850'S RX INPUT CIRCUITRY AS THERE IS NO PROTECTION IN CIRCUIT!!!

Well, that's it. Mod complete. Now all you have to do is figure out how to make use of two simultaneous receiver signals without getting totally confused! By the way, although the external receiver's antenna is automatically disconnected when the TS850 transmits, there will still be plenty of RF in the vicinity - it is probably best to avoid tuning the external receiver to the TS850's transmit frequency, possibly even the same band, or to use an external band-pass filter in the receive line.

Best of luck in the contest OM! 73 de Gary, G4iFB

This mod is a copi from www.g4ifb.com/TS850_mod/ts850_mod.htm with permission from G4iFB.

26-06-2002

add a comment

A Band Decoder for the Kenwood TS-850 HF-Transceiver

Author: Win DK9IP - dk9ip@t-online.de. MODIFICATION.NET

by Winfried Kriegl DK9IP/KH7CD (April 2001)

The Kenwood TS-850 transceiver is still quite popular amongst DXers and contesters but this rig does not have a build-in band decoder as most of the ICOM transceivers do. Especially in a contest setup this feature would be very helpful for a quick band change.

By studying the circuit diagram I discovered a way how to easily add a band decoder to the TS-850. This can be done by using the band signals that control the filter unit and the build-in automatic antenna tuner. The circuit can be added without permanently modifying the unit (i.e. drilling holes) if you follow my recommendations. The supplement requires no special knowledge or the removal of circuit boards but you'll have to solder on a board and some care should be taken not to damage anything.

From here you proceed on your own risk. Don't make me responsible if you fry your radio.

My circuit uses 9 miniature relais (12V DC, spst type) to drive any remote antenna switch. The relay contacts are switched to ground when active (see circuit diagram) but it's also possible to switch to +12V if needed.



I didn't make a PC board layout for this "prototype" yet. Components were soldered on a perforated construction board (size abt. 8.5cm x 5cm). The board was mounted under the removable top cover with 3 screws. This space is reserved for the optional VS-2 Voice Synthesizer which I don't use.



To connect the band decoder board to the transceiver proceed as follows:

- Remove the transceiver top case
- Remove the shield cover of the filter unit X51-3100-00 (7 screws)
- On the filter board locate the 9 pads marked 10A, 28A, 25A, 7A, 21A, 18A, 4A, 14A and 2A between IC2 and connector CN4 (see picture). These pins are on +12V level when the related band is selected
- Solder 9 wires of a 10-wire flat ribbon cable to the pads and connect to the corresponding inputs (33K resistors) on the band decoder board. The remaining wire is connected to +12V as supply voltage for the relais. Use a separate wire for ground connection





I used a DB9 female connector for the relay output signals. The connector can be mounted by replacing the ACC4 connector which is provided for connecting the external antenna tuner AT-300. You won't need this connector with the build-in automatic tuner. Just remove the ACC4 connector and push it back into the case.



The DB9 connector is fixed without additional screws by clamping it between the rear panel and the metal supports. Proceed as follows:



- Loosen all screws of the rear panel. Remove the 3 screws that hold the RTTY/DSP1/DSP2 connector board
- Place the DB9 connector in the center of the ACC4 mounting hole. Fix the screws while clamping the DB9 connector as described above (see picture)
- Connect the DB9-pins to the relay outputs of the band decoder using flat ribbon cable. Ground connection is made via the metal case of the DB9 connector. Remember to connect the case of the DB9-plug to ground.



That's all. Replace shield cover and top case.

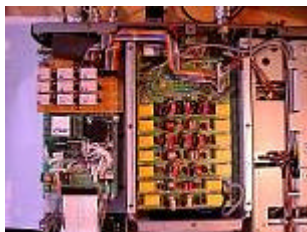

Now you can drive any remote antenna switch with the relay outputs from this band decoder.

This article can also be found at <http://www.dk9ip.de/DK9IPprojects/DK9IPdecod/dk9ipdecod.html>.

This modification has been read 4582 times.

[top of page](#)
[add a comment](#)

11-05-2003

TS850s alc problem

Author: Adrian - adshar64@yahoo.com. [MODIFICATION.NET](http://www.MODIFICATION.NET)

[add a comment](#)

A common ALC fault in the X59-1100-00 DC-DC converter board causes TX output power to cycle up and down in regular cycles due to alc voltage variation. This is dependent on the power supply voltage and will show up usually under 13.5v or less.

Instead of replacing the DC-DC converter board replace R2 and R3, 22kohm SMD resistors with a lesser value. I used 13kohm SMD resistors with great results ;ie no power dropoff symptoms down to 9v supply tested. Have heard of 18Kohm values used with good results too.

DC-DC (X59-1100-00) Component side view

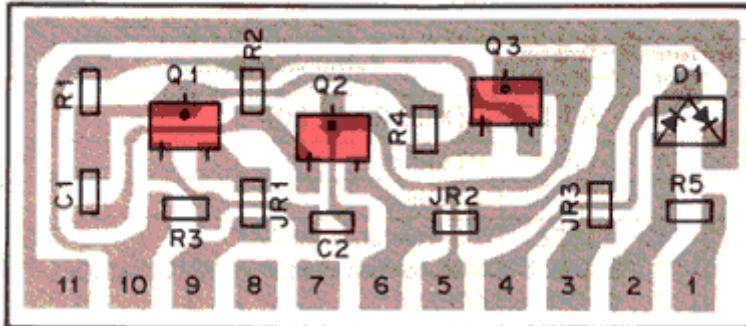

regards Adrian 389

Date: 06-08-2003

User comment

From: Keith

Subject: DC-DC converter (X59-1100-00)

The fault is caused by Q3 (2SA1162Y) a germanium PNP going leaky. changing the resistors in the multivibrator can give a fix but the fault will eventually return as Q3 dies completely. Either replace Q3 or a better solution is to replace Q3 with a BCW30 and change R4 to 100k.

This modification has been read 2560 times.

[top of page](#)
[add a comment](#)

11-06-2003

[add a comment](#)

Noise Blanker Mod Kenwood TS-850

Author: Adrian - adshar64@yahoo.com.MODIFICATION.NET

This mod solves the TS-850S noise blanker problem in eliminating electrical interference and makes the nb design the same as the ts940 which doesn't have this problem. Results are outstanding. For the sceptical; Its easy to reverse mod.

The NB board reference is X59-1100-00 and it is located directly under the radio speaker. Remove the upper part of the cabinet and unplug the loud speaker. You will have to remove 4 screws and unplug 3 connectors in order to extract the board.

The picture here shows the board mods required.

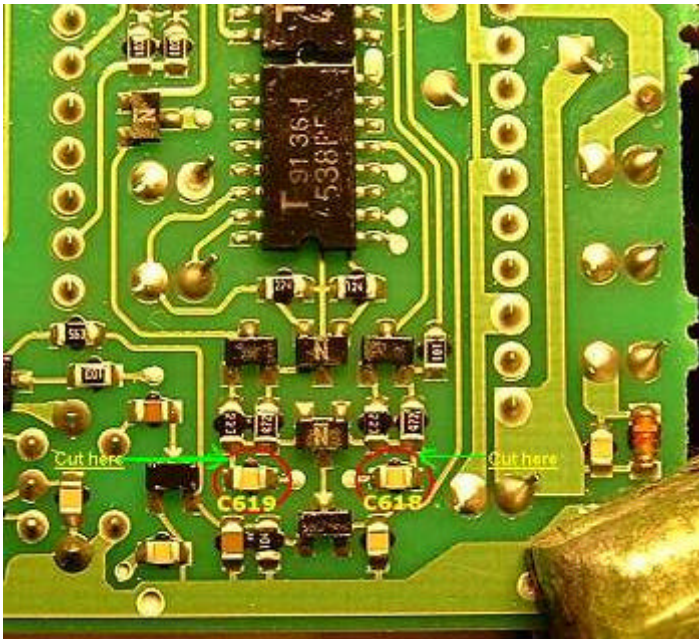

The capacitors to isolate are C618 and C619

Regards Adrian

This modification has been read 2197 times.

[top of page](#)
[add a comment](#)

01-11-2003

TS-850s noise blanker mod

[add a comment](#)

Author: B&B Technical Services - bbtech1@comcast.net. [MODIFICATION.NET](http://www.MODIFICATION.NET)

Removing D618 and D619 on the noise blanker portion of the RF unit (small one, just under the power switch, front left of radio) will increase the effectiveness of the TS-850 noise blankers.

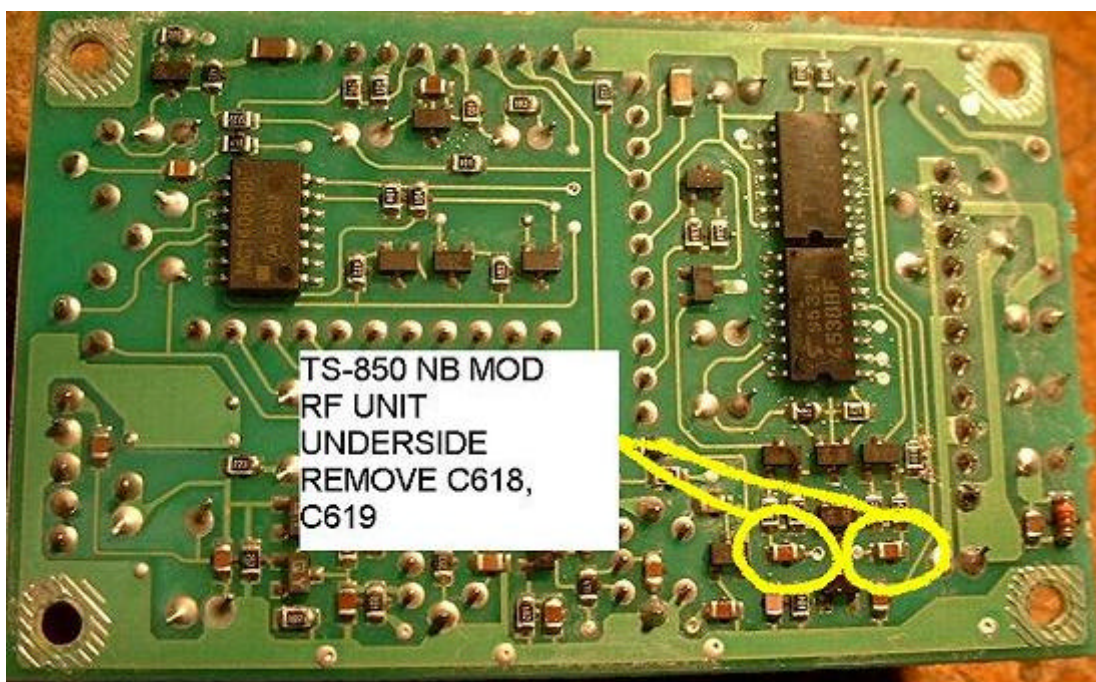

Bill and Bonnie Leahy
K0ZL, KB0HTC

Date: 02-11-2003

User comment

From: DG2IAQ, Jochen
Heilemann

Subject: Remove capacitors - not diodes !!

Hello,
the printed text of B&B Tech is wrong as described to remove "D618/D619". For sure it must be "C618 and C619" (=capacitors, not diodes). The parts are correctly named on the picture, not in the text. But don't worry, you would never find the diodes, named D618/D619, hihi.

You can find the capacitors on a part of the "RF UNIT PCB".

73,
Jochen (DG2IAQ)

This modification has been read 773 times.

[top of page](#)
[add a comment](#)

28-11-2003

TS-850 fan speed modification

Author: Bill, K0ZL - bbtech1@comcast.net. MODIFICATION.NET

I worked up a fan speed mod for the TS-850S, for RTTY, AM, FM and other high-duty cycle ops
Jumpering R601 on the Digital D unit will increase the fan speed about 50 percent; noise increa
Digital D unit is located right alongside the PA unit, under the filter unit, accessed from the top

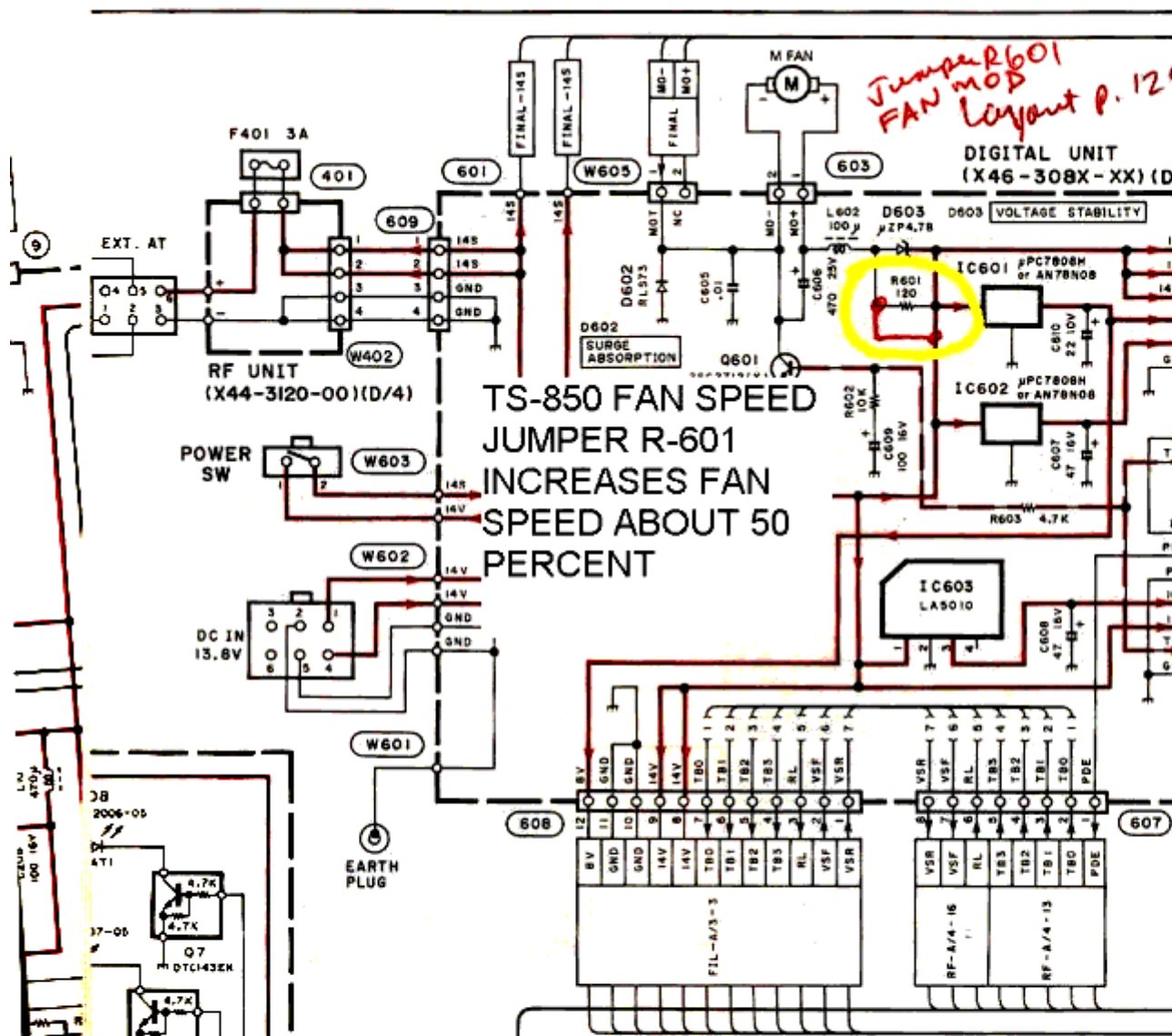

Carefully unplug the ribbon connector at the back of the board, then the two-conductor plug at forget to remove the two clips holding the tabs of the regulator chips to the casting.

I use a small toggle switch on the back, so that fan speed can be returned to normal; it's so quiet not need it unless operating in a church or library, hi!

This modification has been read 449 times.

advertising on www.mods.dk
for only \$19 monthly

Have you any tips, trick or modifications you can't find here, please [send a mail](#) to me.
Can't you find a modification, then don't e-mail me please. All modification that i have,
is listed on this site.!

Have you problem with www.mods.dk then you can visit the [support](#) page.

[Start page](#)

